

TYPICAL ARTP-3DR-17SC INSTALLATION

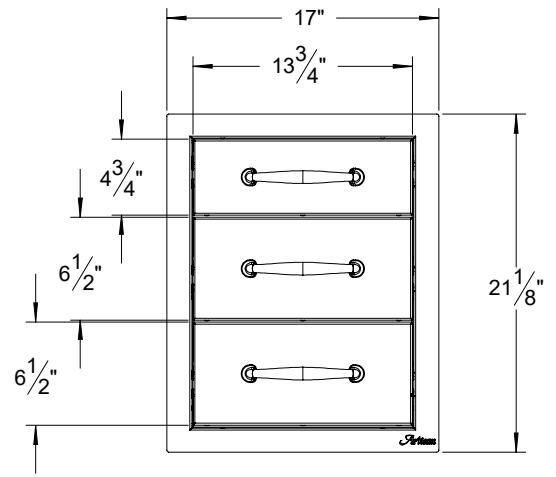

COUNTER FRONT CUTOUT REQUIREMENTS

